



TREND NETWORKS

SignalTEK



Quick Reference Guide
156848 Issue 4
© TREND NETWORKS 2020

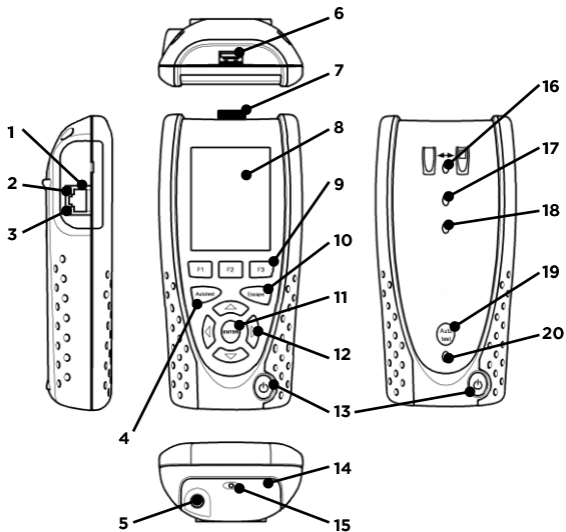

1	Cable socket	11	ENTER button
2	Ethernet LED	12	Cursor buttons
3	Activity LED	13	Power button
4	Autotest button	14	Battery module
5	DC in connector	15	Charging indicator LED
6	USB socket	16	Link LED
7	Wi-Fi adapter	17	Pass/Fail LED
8	Touchscreen display	18	Saved LED
9	Function buttons	19	Remote autotest button
10	Escape button	20	Battery status LED

Charging Indicator LED (15)	Status
Green	Charging
Off	Charging complete
Flashing	Not charging

Pass/Fail LED (17)	Status
Green	Test passed
Red	Test failed

Battery Status LED (20)	Status
Green (Power ON)	Battery level is sufficient for use
Red (Power ON)	Battery level is low but still operational
Off	Power OFF

Four Ways to Navigate

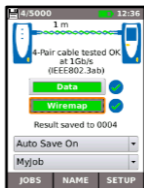

Escape - returns to previous screen
ENTER - accepts selection

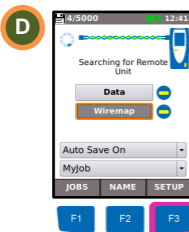

Job Setup

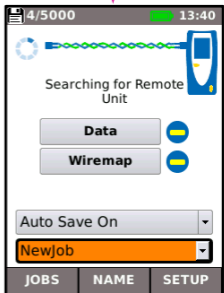
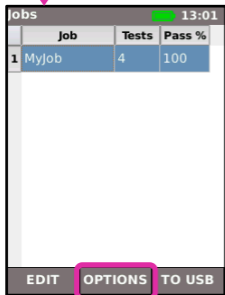
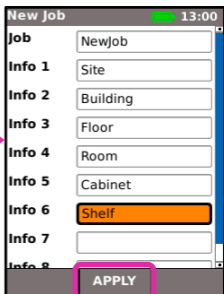

Test Setup



- Cat 3
- Cat 5e
- Cat 6
- Cat 6A
- Cat 7 and 7A
- Cat 8
- USOC8 1 pair
- USOC8 2 pair
- USOC8 3 pair
- USOC8 4 pair
- ETH 1236
- ETH 1278
- PROFINET 4W
- COAX RGxx
- ISDN BRI
- DB
- Custom**
- UTP
- STP
- UTP/STP**
- NONE
- 568A
- 568B**
- USOC
- TERA

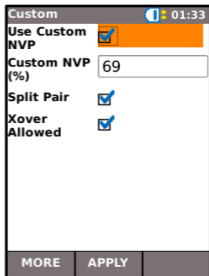
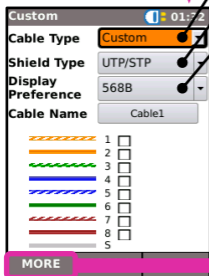

Cable Testing

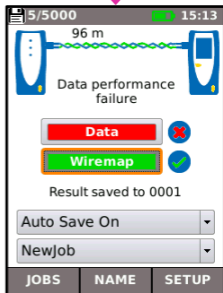
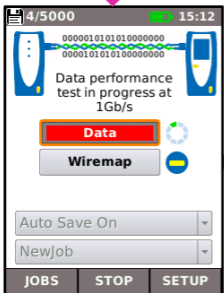
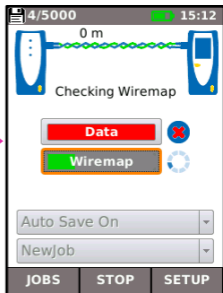
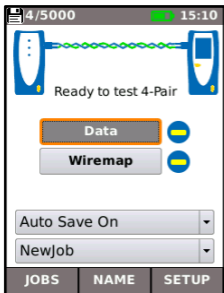

Viewing Test Results

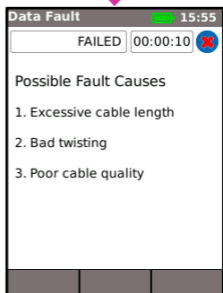
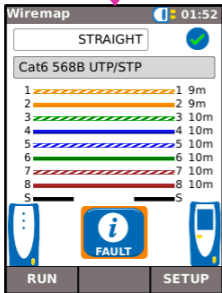
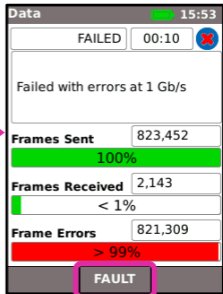
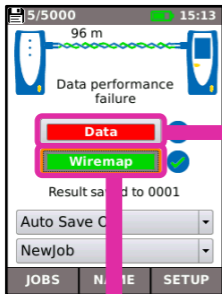

Test Reports

5 tests are saved /
memory capacity
is 5000 tests

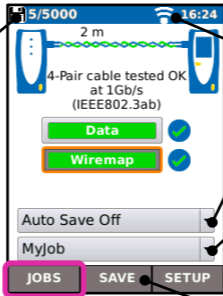

Indicates Wi-Fi
is enabled

Select result
saving mode

Select current
Job

Save the result
manually when
Auto Save is Off

View
result

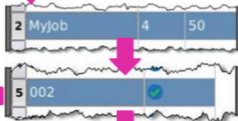

Select job

Select result



OR Save
report to
USB

OR Smartphone
downloads reports using
TREND AnyWARE
app. for Android™ /
Apple

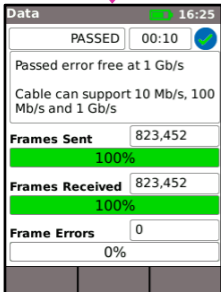

Menu Map

